



Mallia™ 2 810 45 2 830 45 2 832 45 2 834 45 2 820 45 2 838 45
 2 810 46 2 830 46 2 832 46 2 834 46 2 820 46 2 838 46

- Push Button NO + DND/CUR Sign
- 2 Gang Switch for DND/CUR



Characteristics

• Voltage	• Specification		
230V ~ 50Hz/60Hz	10A Push button 1W Display unit	2 x 2, 5 mm ² Max.	-5 °C +40 °C

Installation

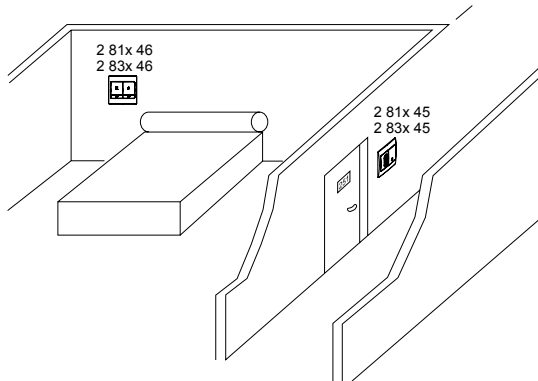

2 81x 45
2 83x 45

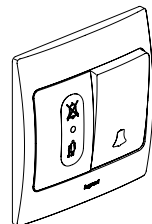
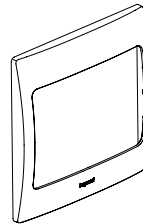
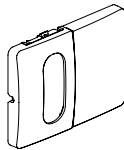
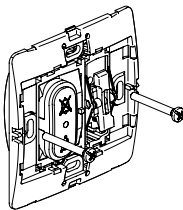

2 81x 46
2 83x 46

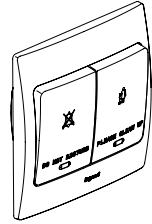
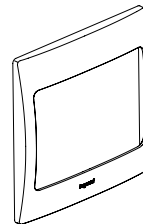
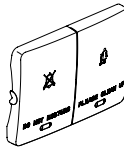
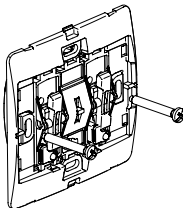

N.B. Plate should be purchased separately except the product in white.

Description (2 81x 45 2 83x 45)

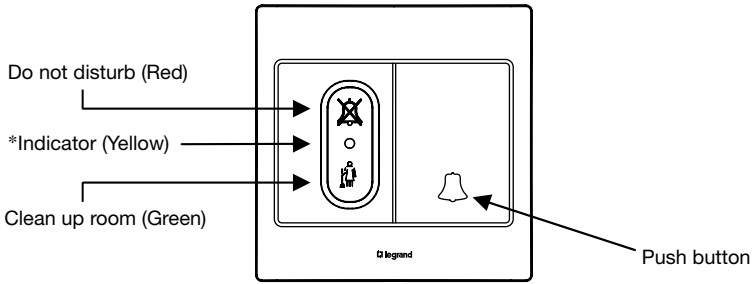

* Optional indicator:
 For Example, for indicating room occupancy when
 connect to key card switch 281 x48 283 x48.

Wiring

